

VFINEFM0750: FINELINE - FLOOR MOUNTED VANITY COMBO

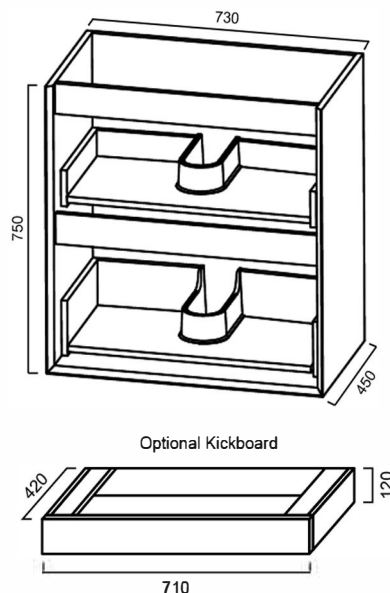

VFINEFM0750: 730mm x 750mm x 450mm



DESCRIPTION

- The Fineline is a contemporary, floor mounted bathroom vanity and ceramic top combo
- 730mm long x 450mm wide x 750mm high
- Cabinet is constructed from high moisture resistant (HMR boards) which reduce the risk of mould and bacteria. Vanity top is made from vitreous china ceramic
- The vanity surface is completed with a 2 Pac polyurethane finish which makes it resistant to conditions normally found in bathrooms such as heat, moisture and stains, but also marring and chipping to the vanity surface. This guarantees that the vanity will continue to look great long after purchase
- Conforms to the lowest formaldehyde percentage ratings (up to the highest Australian and International environmental and health standards)
- Designed to guarantee product longevity through its solid construction. Every drawer has solid 16mm panels and backing and are screwed double front
- Installed with DTC runners and hinges, manufactured from high grade materials, and incorporates soft close technology, reducing wear and tear and increasing the lifespan of the vanity
- Black and white drawer fronts are a 2 Pac satin finish, while the oak and ash fronts are vinyl wrapped
- No handles provides an elegant and sleek look

Tap Holes: 1 or 3

Mounting: Legs or Kickboard

Number of Bowls: Single

Front Panel: Oak, Ash, Black or White

Bowl Style: Square or Round

Overflow: Yes

WARRANTY

1 Product Replacement Warranty

- Product replacement does not include installation or removal of the original product
- Check product for damage before installation - installing a damaged product voids warranty

IMPORTANT NOTICE

- All pictures and drawings on this brochure are representational only, changes in the product may have occurred since time of print.
- All prices on this brochure and The Sink Warehouse website are subject to change without notice.
- Tap and waste not included in the price of the basin and needs to be purchased additionally.

To contact The Sink Warehouse email us at info@sinkwarehouse.com.au