

TECH175U: 730mm x 450mm x 200mm

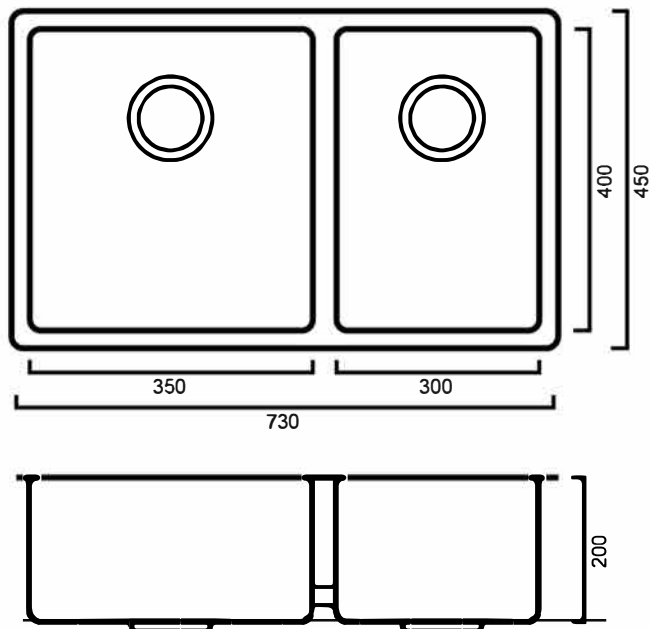

DIMENSIONS

Length: 730mm | Width: 450mm | Depth: 200mm

DESCRIPTION

- Contemporary stainless steel handmade sink
- 730mm long x 450mm wide x 200mm deep
- Designed to be undermounted, but can be inset
- Features a full size bowl and one 3/4 bowl without drainer for a high degree of comfort and functionality
- No drainer saves bench space
- Modern brushed finish
- Supplied with two 90mm basket wastes

WARRANTY

25 Year Replacement Warranty / 2 Years Parts & Labour

- Product replacement does not include installation or removal of the original product
- Check product for damage before installation - installing a damaged product voids warranty

IMPORTANT NOTICE

- All stainless steel products are constructed from 304, 18/10 grade stainless steel.
- It is strongly recommended that any cut-outs made to your bench top is made based on the individual product dimensions.
- All pictures and drawings on this brochure are representational only, changes in the product may have occurred since time of print.
- All prices on this brochure and The Sink Warehouse website are subject to change without notice.